



South Bay Foundry

WWW.SOUTHBAYFOUNDRY.COM

PHONE: (619) 956-2780 FAX: (619) 956-2788

SBF 1314

22" MANHOLE
FRAME AND COVER
SANITARY SEWER

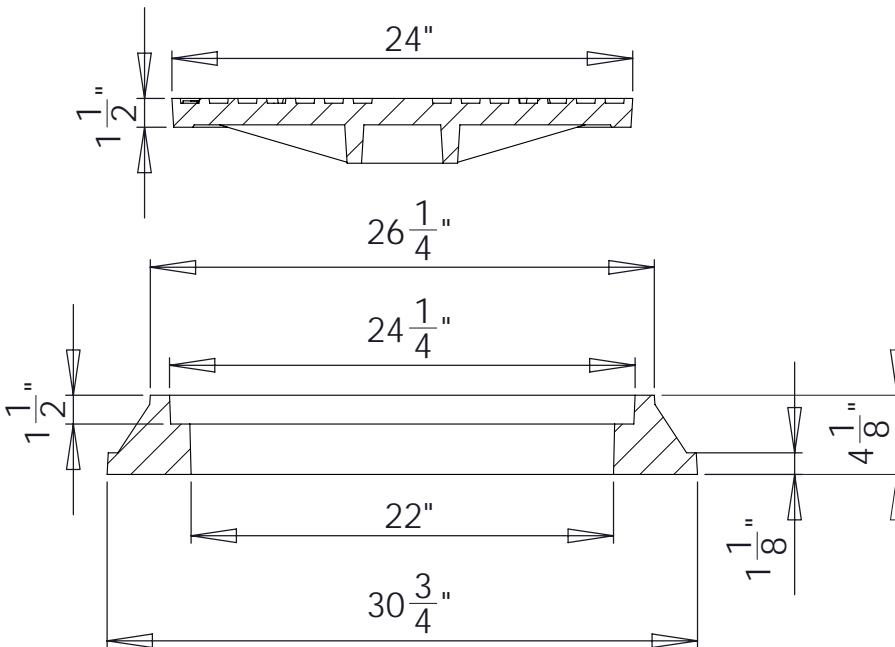
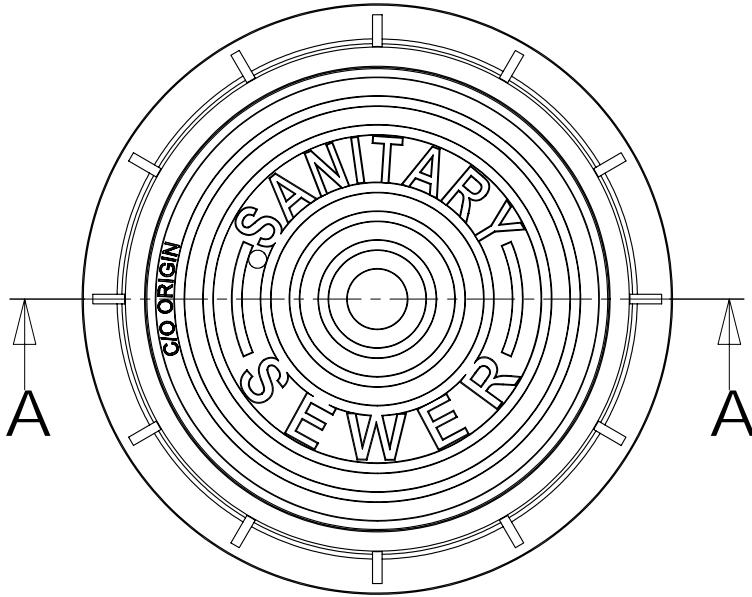

SECTION A-A

SET WEIGHT	
FRAME	190 LB
COVER	155 LB
TOTAL	345 LB

GENERAL INFORMATION

- *MATERIALS CONFORM TO ASTM A48 CLASS 35B
- *BEARING SURFACES MACHINED FOR CLOSE, QUIET FIT
- *CASTINGS SHALL BE DIPPED IN BLACK BITUMINOUS PAINT
- *FRAME AND COVER EXCEEDS H-20 WHEEL LOADING

APPROVED

BY:

TITLE:

AGENCY:

DATE: