

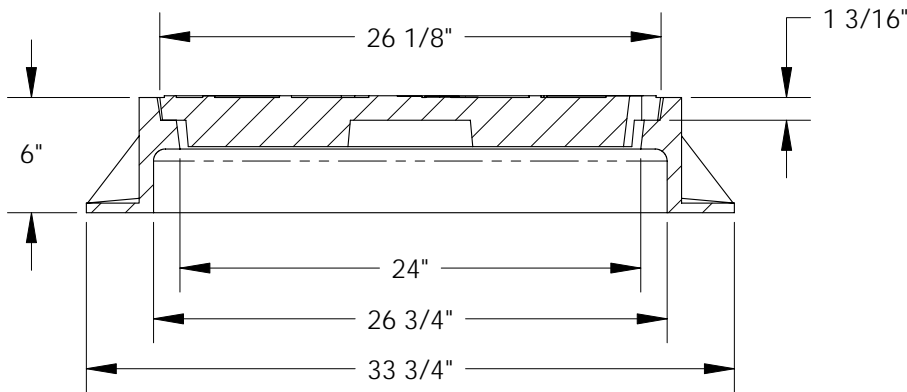

South Bay Foundry

9444 Abraham Way Santee, CA 92071 (619) 956-2780
 42 North Cluff Lodi, CA 95240 (209) 367-1940
 895 S. Inland Center Dr. San Bernardino, CA (909) 888-3334

SBF 1370 MANHOLE FRAME & COVER A78/GL

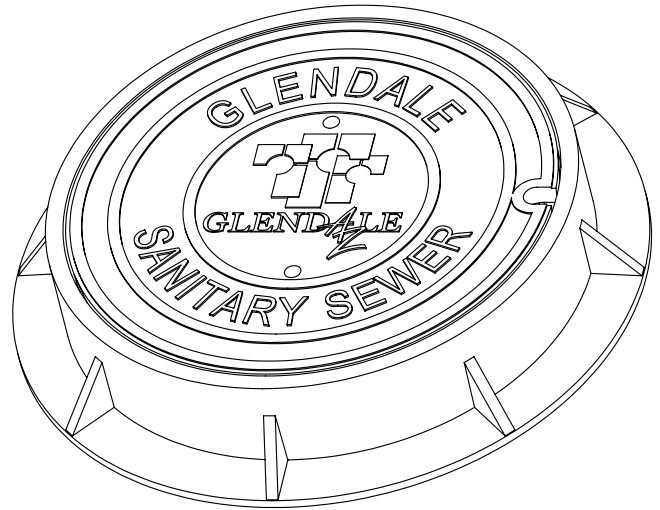

CLASS 35B

Set Weight	
Frame	170 Lbs
Cover	180 Lbs
Total	350 Lbs

General Information

- All materials used shall conform to ASTM A48, Class 35B, using wheel load test method to 48,700 lbs.
- Frame and cover bearing surfaces shall be machined to assure close, quiet fit.

Approved	
By:	
Title:	
Agency:	
Date:	
Comments	